



LK Armatur

UNDERFLOOR HEATING

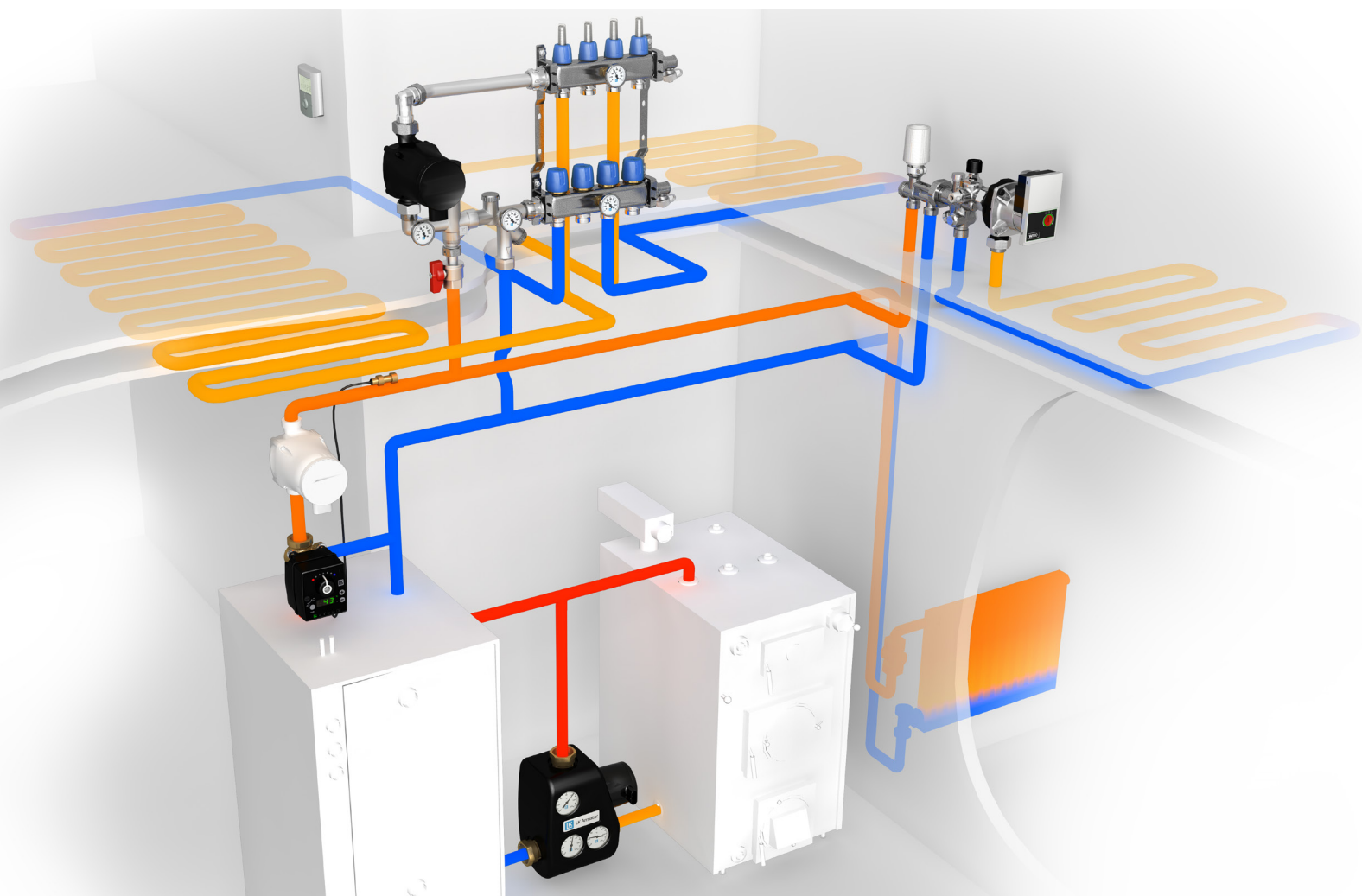


PRODUCTS FOR UNDERFLOOR HEATING

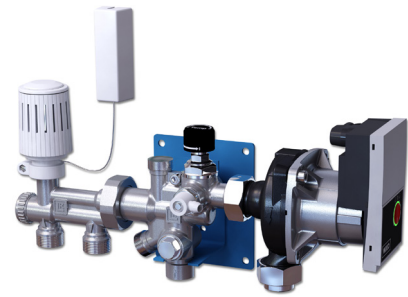


Table of Contents

LK 420 Minishunt	3
LK 421 Manifold Shunt	4
LK 422 Manifold Shunt	5
Spare Parts and Accessories	6
LK 430 Manifold	7
LK 435 OptiFlow	9
LK 440 EasyHeat	11



LK 420 Minishunt



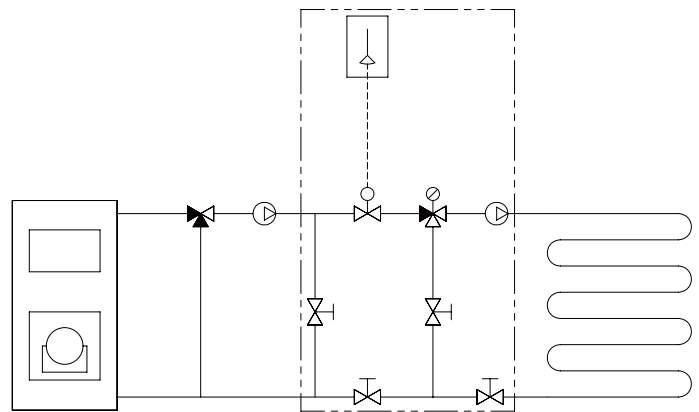
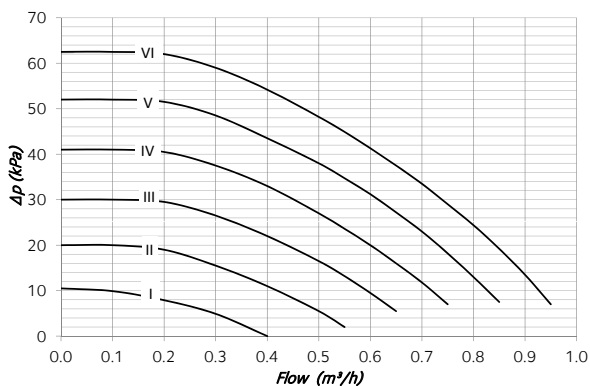
TECHNICAL DATA

Voltage	230 VAC, 50 Hz
Working temperature, primary	Min. +5 °C/Max. +90 °C
Working temperature, secondary	Min. +12 °C/Max. +63 °C
Ambient temperature	Min. -20 °C/Max. +35 °C
Max. working pressure	0.6 MPa (6 bar)
Media	Water - Glycol Mixture max. 50%
Thread standard	G - female thread G - male thread
Material, valve body	Nickel-plated brass EN 12165 CW617N
Circulating pump	Wilo Yonos PARA RSB 15/6

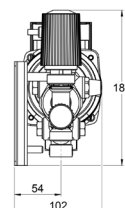
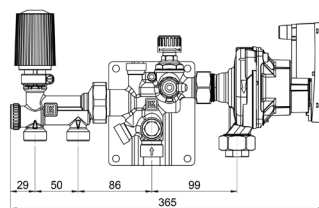
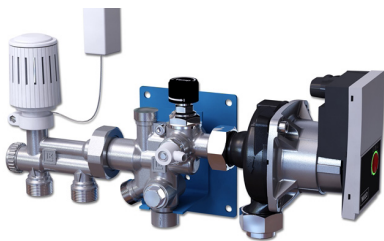
LK 420 Minishunt is a thermostat controlled unit for connection of small underfloor heating systems to an existing heating system. The shunt unit consists of a circulating pump, a maximum limiter function for the supply temperature, a return valve and a thermostat valve unit, fitted with a room thermostat and room temperature sensor, connected to a capillary pipe. The guideline capacity for LK 420 is max. 60 m² depending on heating needs and installation method.

The LK 420 Minishunt can be assembled in both left and right configurations. The shunt unit must be mounted at a higher level than the underfloor heating installation to assist air bleeding.

PUMP CHARACTERISTICS



LK 420 - COMPRESSION FITTING ALT. MALE THREAD / FEMALE THREAD



ARTICLE NO.	DIMENSION	KVS M ³ /H	KVS2 M ³ /H	WEIGHT KG
296994	M ¾" EuroCone / F ½"	1.1	0.5	4.2

Dimension = Prim. / Sec. connection
Kvs 2 - with thermostat m³/h

LK 421 Manifold Shunt

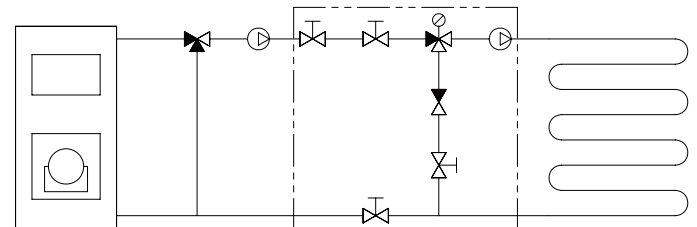


LK 421 Manifold Shunt is a complete pre-manufactured shunt unit with a 2-way control valve for systems with the main pump in the primary circuit. The shunt group is delivered fitted with controls for both flow (speed and temperature) and high limit setting of the supply temperature.

The shunt group is designed to work with primary heat sources fitted with weather compensation. LK 421 can also be equipped with control systems for electronic heat regulation of the underfloor heating circuit. As the unit is fitted with a high limit temperature controller, the shunt group can also be used in systems with constant primary supply temperatures.

LK 421 Manifold Shunt is supplied with an automatic speed controlled pump for reduced energy consumption and greater efficiency. The guideline capacity of LK 421 is 150 m² at 80W/m² based on a primary supply temperature of 70 °C.

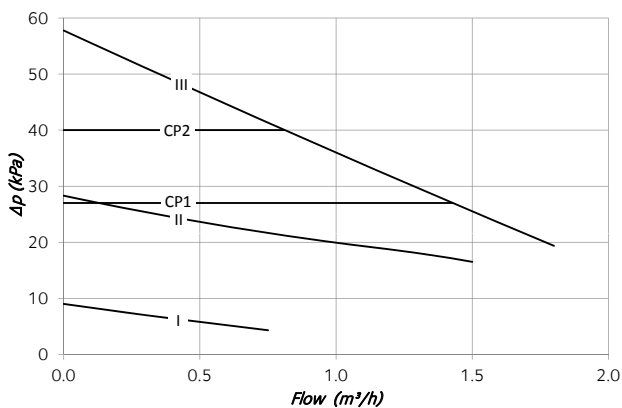
LK 421 can be mounted directly onto the manifold from the right or left. Two manifold supply pipes of different lengths are supplied. The longer pipe is used when mounting to the left of the manifold. When fitting to the right, use the shorter pipe, reposition the thermometers and rotate the pump through 180°.



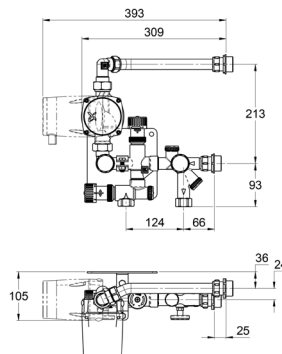
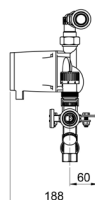
TECHNICAL DATA

Voltage	230 VAC, 50 Hz
Working temperature, Primary	Min. +5 °C/Max. +90 °C
Secondary	Min. +30 °C/Max. +65 °C
Ambient temperature	Min. +5 °C/ Max. +40 °C
Max. working pressure	0.6 MPa (6 bar)
Media	Water - Glycol mixture max. 50%
Thread standard	G - male thread, G - female thread
Circulating pumps	Grundfos Alpha 2L 60
Material, valve body	Nickel-plated Brass EN 12165 CW617N
Material, supply pipe	Stainless steel EN 1.4404

PUMP CHARACTERISTICS



LK 421 - FEMALE THREAD / MALE THREAD



ARTICLE NO.	DIMENSION	KVS M ³ /H	KVS2 M ³ /H	WEIGHT KG
296995	F ¾" / M 1"	2.5	5.0	6.0

Dimension = Prim. / Sec. connection

Kvs 1 - control valve m³/h, Kvs 2 - control valve /shut-off primary return m³/h

LK 422 Manifold Shunt



TECHNICAL DATA

Voltage	230 VAC, 50 Hz
Working temperature	
Primary	Min. +5 °C/Max. +90 °C
Secondary	Min. +30 °C/Max. +65 °C
Ambient temperature	Min. +5 °C/Max. +40 °C
Max. working pressure	0.6 MPa (6 bar)
Media	Water - Glycol mixture max. 50%
Thread standard	G - male thread, G - female thread
Circulating pumps	Grundfos Alpha 2L 60
Material, valve body	Nickel-plated Brass EN 12165 CW617N
Material, supply pipe	Stainless steel EN 1.4404

LK 422 Manifold Shunt is a complete pre-manufactured shunt unit with thermostat controlled constant supply temperature. The shunt group is for systems with the main pump in the primary circuit.

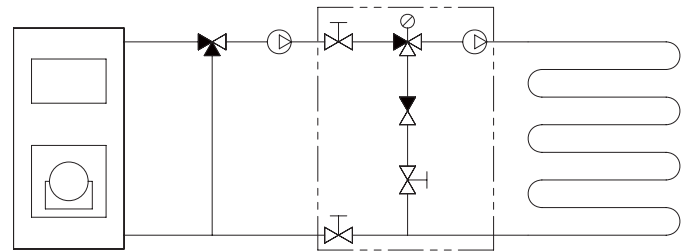
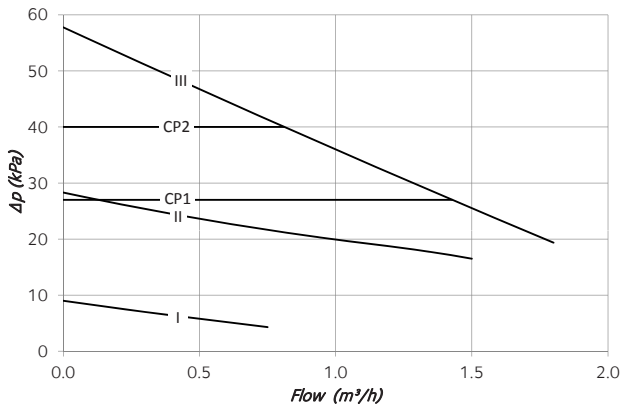
The LK 422 is a 2-way shunt unit that provides a constant flow in the secondary circuit and a variable flow in the primary circuit.

LK 422 Manifold Shunt is supplied with an automatic speed controlled pump for reduced energy consumption and greater efficiency. The guideline capacity of LK 422 is 130 m² at 80W/m² based on a primary supply temperature of 70 °C.

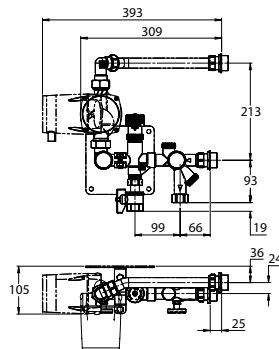
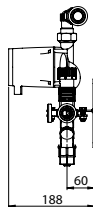
A bracket for wall mounting and thermometers are available - see under Accessories.

LK 422 can be mounted directly onto the manifold from the right or left. A manifold supply pipe for use when mounting to the left of the manifold is supplied. When fitting from the right, shorten the supply pipe by about 50 mm, reposition the thermometers and the pump through 180°.

PUMP CHARACTERISTICS



LK 422 - FEMALE THREAD / MALE THREAD



Article no.	Dimension	Kvs m ³ /h	Kvs2 m ³ /h	Weight kg
297562	F ¾" / M 1"	2.7	5.0	5.3

Dimension = Prim. / Sec. connection

Kvs 1 - control valve m³/h, Kvs 2 - control valve /shut-off primary return m³/h

Spare Parts and Accessories



LK 420 MINISHUNT



ARTICLE NO.	ARTICLE	POSITION
095219	Circulating pump Wilo Yonos PARA RSB 15/6	1
055603	Thermostat with sensor	2

LK 421 MANIFOLD SHUNT



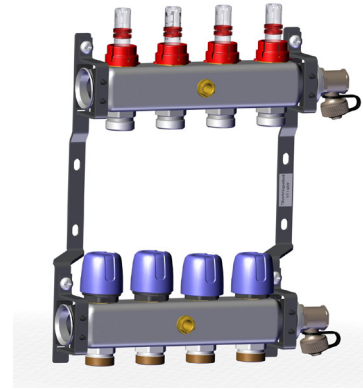
ARTICLE NO.	ARTICLE	POSITION
187040	Circulating pump Grundfos Alpha 2L 15-60	1
095018	Thermometer T40, 0° - 80°C	2

LK 422 MANIFOLD SHUNT



ARTICLE NO.	ARTICLE	POSITION
187040	Circulating pump Grundfos Alpha 2L 15-60	1
095018	Thermometer T40, 0° - 80°C	2
095221	Bracket	-

LK 430 Manifold



TECHNICAL DATA

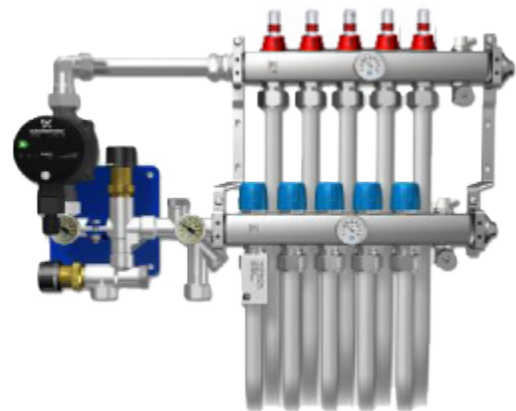
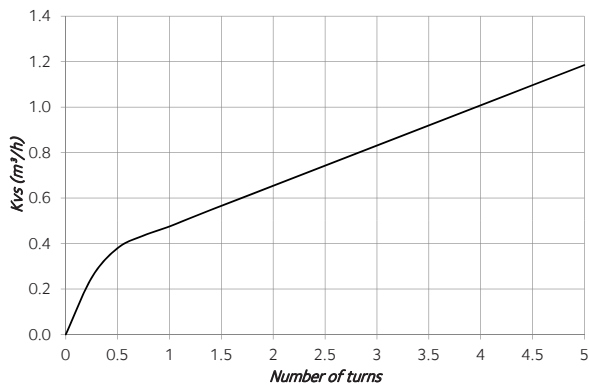
Working temperature	Min. +5 °C/Max. +70 °C (max. +85 °C briefly)
Ambient temperature	Min. -20 °C/Max. +40 °C
Max. working pressure	1.0 MPa (10 bar)
Max. pressure difference	100 kPa
Flow indication, scale	0.5 - 5 l/min. ±10%
Thermometer	0° - +80 °C
Media 1	Water
Media 2	Water - Ethylene glycol Mix- ture max. 50%
Media 3	Water - Propylene glycol Mixture max. 50%
Media 4	Water - Ethanol Mixture max. 50%
Thread standard	G - female thread G - male thread
Material, manifold	Stainless steel EN 10088-3 1.4306
Material, threaded union parts/isolation valves	Nickel plated brass EN 12165 CW617N

LK 430 is a manifold for 2 - 12 underfloor heating circuits. It is manufactured in stainless steel and is delivered pre-mounted to a bracket. The manifold is equipped with filling / drainage valves. The upper manifold marked FLOW is fitted with flow indicators and adjustment valves for setting the respective circuit flows. The lower manifold marked RETURN has manually operated valves for shutting off each respective circuit. These valves are normally replaced with thermoelectric actuators. Thermometers for the return and flow manifolds are available - see under Accessories.

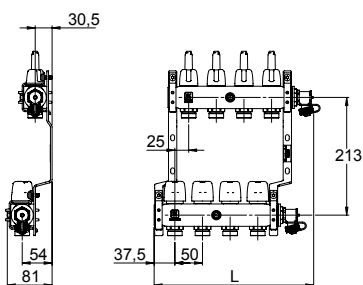
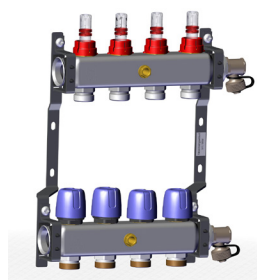
LK 430 can also be supplied with an LK 435 OptiFlow balancing valve for easy adjustment of the circuit flow. The flow rate is clearly indicated on a transparent scale - see under Accessories. For more information see the product sheet for OptiFlow on page 14.

The heat supply can be connected to the manifold from the left or the right side. The manifold is delivered ready for connection from the left. When connecting from the right, reposition the drainage valves.

VALVE CHARACTERISTICS



LK 430 - FEMALE THREAD / MALE THREAD



ARTICLE NO.	NO. OF CIRCUITS	DIM. HEAT SUPPLY CONNECTION	DIM. CIRCUIT CONNECTION	DIM. CONNECTION FOR FILLING/ DRAINAGE	KVS ADJUSTMENT VALVE M ³ /H	KVS RETURN VALVE M ³ /H	L MM	WEIGHT KG
297311	2	F 1"	M 3/4" EuroCone	M 1/2"	1.1	2.5	190	2.8
297312	3	F 1"	M 3/4" EuroCone	M 1/2"	1.1	2.5	240	3.2
297313	4	F 1"	M 3/4" EuroCone	M 1/2"	1.1	2.5	290	3.6
297314	5	F 1"	M 3/4" EuroCone	M 1/2"	1.1	2.5	340	4.2
297315	6	F 1"	M 3/4" EuroCone	M 1/2"	1.1	2.5	390	4.7
297316	7	F 1"	M 3/4" EuroCone	M 1/2"	1.1	2.5	440	5.1
297317	8	F 1"	M 3/4" EuroCone	M 1/2"	1.1	2.5	490	5.7
297318	9	F 1"	M 3/4" EuroCone	M 1/2"	1.1	2.5	540	6.0
297319	10	F 1"	M 3/4" EuroCone	M 1/2"	1.1	2.5	590	6.5
297320	11	F 1"	M 3/4" EuroCone	M 1/2"	1.1	2.5	640	7.0
297321	12	F 1"	M 3/4" EuroCone	M 1/2"	1.1	2.5	690	7.5

SPARE PARTS AND ACCESSORIES

ARTICLE NO.	ARTICLE
095018	Thermometer T40 / 0° - 80°C
095182	Drainage valve
090275	LK 435 OptiFlow, 2-16 l/min
090276	LK 435 OptiFlow, 4-36 l/min

LK 435 OptiFlow



TECHNICAL DATA

Working temperature	
Water/Glycol 50/50%	Min. -20°C / Max. +80°C (+90°C briefly)
Water/Ethanol 70/30%	Min. -20°C / Max. +70°C (+85°C briefly)
Max. working pressure	1.0 MPa (10 bar)
Max. differential pressure	100 kPa
Media	Water - Glycol mixture max. 50% Ethanol mixture max. 30%
Material, valve body	Nickel-plated Brass EN 12165 CW617N
Flow ranges	2-16 l/min 4-36 l/min
Accuracy, flow meter	+/- 12%
Thread standard, adjustment valve inlet	G - male thread
Thread standard, adjustment valve outlet	G - female thread

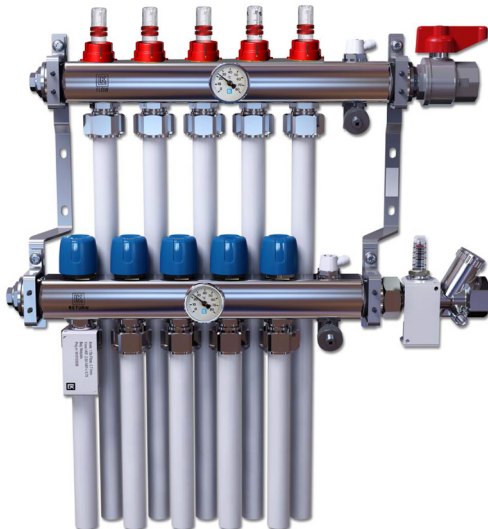
LK 435 OptiFlow is a group valve for flow adjustment of hydraulic systems such as underfloor heating, traditional heating and cooling systems. Adjustments are easily made using an Allen key. No measuring equipment is needed. The flow rate is read off directly from the visual flow indicator. The flow meter continuously measures and displays the actual flow rate during operation.

LK 435 OptiFlow has a MemoStop function for locking the setting. This means that the valve can be used as a shut-off valve without losing settings. A marking plate for labelling and documenting the setting is enclosed. LK 435 OptiFlow can be supplemented with a thermometer and threaded union parts, straight or angular, with rotating nut for simple assembly to, for example, an LK 430 Manifold RF - see under Accessories. The thermometer is placed in the valve's integrated sensor pocket.

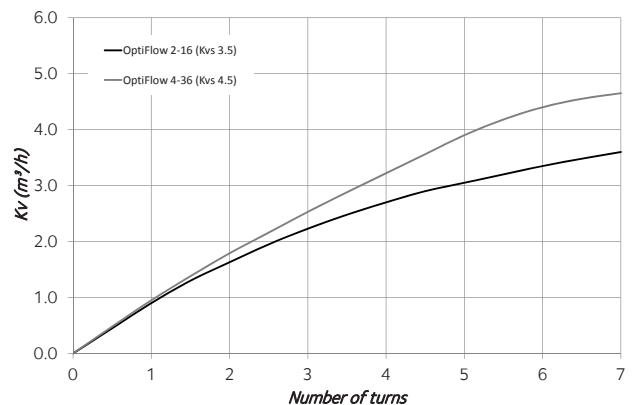
The valve can be mounted in any position. The arrow on the valve body indicates the flow direction. For accurate measurement a straight piece of tube at least of the same length as the valve body should precede the balancing valve. When assembling to an LK 430 Manifold RF the adjustment valve can be fitted directly to the manifold, thus replacing the shut-off valve.

The flow meter is designed so that the fluid does not flow through the glass in order to protect it from debris and dirt. However, after a period of time the glass may still have to be cleaned as the fluid often becomes contaminated and blackened. It is then easy to remove the glass to clean it. The function/setting of the valve is not affected by deposits in the glass.

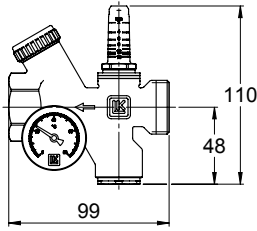
Except for cleaning of the glass, the group valve normally requires no maintenance. The installation should be checked regularly.



VALVE CHARACTERISTICS

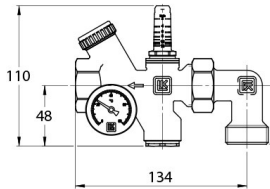
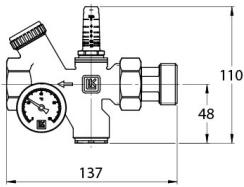


LK 435 - MALE THREAD / FEMALE THREAD



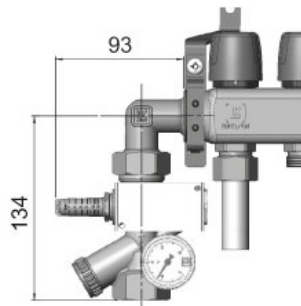
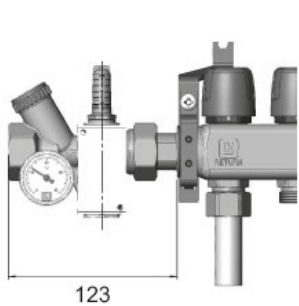
ARTICLE NO.	DIMENSION	KVS M ³ /H	FLOW RANGE	WEIGHT KG
090275	Adjustment valve - M 1" / F 1"	3.5	2-16 l/min	0.5
090276	Adjustment valve - M 1" / F 1"	4.5	4-36 l/min	0.5

SPARE PARTS AND ACCESSORIES



ARTICLE NO.	ARTICLE	POSITION
095222	Threaded union part straight G 1" with rotating nut	1
095223	Threaded union part angle G 1" with rotating nut	2
095018	Thermometer T40, 0° - 80°C	-

WITH LK 430 MANIFOLD RF



LK 440 EasyHeat



TECHNICAL DATA

Circulating pump	Grundfos UPM3 AUTO L
Protection class	IP 21
Operating thermostat	Max 60 °C
Expansion tank	12 litres
Safety valve	1,5 bar
Max. glycol solution	30%
Boiler volume	2,8 litres

The LK 440 EasyHeat is a complete portable electrically heated boiler. It is primarily meant to be used as a temporary heater, e.g. for drying concrete slabs installed with under floor heating and for heating buildings under construction.

LK 440 EasyHeat is available in two versions, with 3-phase 400V or 1-phase 230V.

The total output capacity on 3-phase 400V is 9 kW and works in two steps of 4.5 kW.

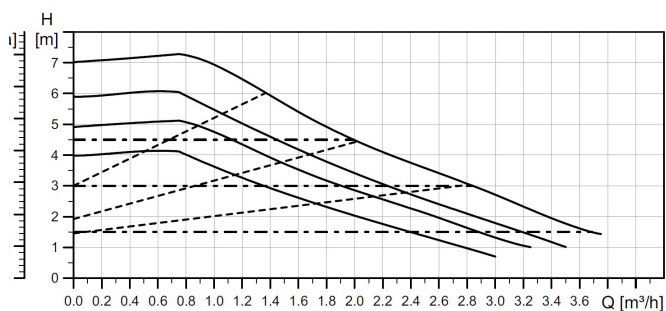
The total output capacity on 1-phase 230V can be manually set between 2 or 3 kW.

The boiler is supplied complete with a circulation pump, an expansion tank, and auxiliary devices including a safety valve and air vent valve.

Connection to the under floor heating manifold or heating system is simple, using steel-reinforced flexible hoses.

Temperature regulation is controlled by the boiler's operating thermostat.

CAPACITY DIAGRAM



LK 440



ARTICLE NO.	DIMENSION	VOLTAGE	POWER	SAFETY THERMOSTAT	L MM	B MM	H MM	WEIGHT KG
298470	F 1"	3-phase 400V Boiler must be protected using 3 x 16 A fuses (max. current 13.5 A)	9 kW in two stages at 4.5 kW	70°C	710	430	650	30
298588	F 1"	1-phase 230V Boiler must be protected using 8,5 A 2 kW, 13 A 3 kW	2 alt 3 kW	80°C	710	430	650	30



LK Armatur, A One-Stop Supplier of HVAC products

LK Armatur AB is part of the LK-Group and an important supplier of valves, components, prefabricated units and electronic heat regulation for the global OEM and distributor market.

LK Armatur produces more than one and a half million valves per year, ranging from simple standard valves to sophisticated, customized special products.

We focus on customers who see energy saving and environmental awareness as a matter of course and has stringent requirements for quality, customization and delivery reliability.



Do you want to know more?
Scan the QR code or visit our website.
www.lkarmatur.se

LK Armatur AB

Garnisonsgatan 49
SE-254 66 Helsingborg
Sweden

Phone: +46 (0) 42 16 92 00
Fax: +46 (0) 42 16 92 20
info@lkarmatur.se
order@lkarmatur.se
www.lkarmatur.se